

**Strength, Style and Security  
for your home and family**

New! Balcony Breeze and  
Corner Sliding Glass Doors

**Sentinel**

by  Impact Resistant  
Windows & Doors





## Why Sentinel Impact Resistant Windows and Doors?



Sentinel by CGI has received the prestigious 2011 Crystal Achievement Award.

An investment in hurricane impact resistant Sentinel Windows and Doors for your home or commercial property is a very wise decision. Sentinel Windows and Doors are manufactured and backed by CGI, founded in 1992 and one of the original pioneers in design and manufacture of high performance impact hurricane resistant windows and doors. CGI's reputation for building high quality windows and doors makes CGI's products the preferred choice of architects, developers, builders and homeowners wherever impact resistant windows and doors are required.

Sentinel's complete line of windows and doors are custom manufactured to enhance the aesthetics of every



architectural style while delivering protection from the most extreme weather conditions.

Sentinel Windows and Doors are the best choice to satisfy your window and door needs. Contact a Sentinel dealer today to learn more and see why an investment in Sentinel is the right decision and an outstanding value.

Selecting Sentinel as your window and door choice is also a smart investment for the following reasons:

- Sentinel impact resistant products increase the resale value of your property
- Sentinel impact products will lower your property insurance premiums in most instances

- Sentinel's laminated impact glass reduces energy requirements for heating and cooling your property
- Sentinel laminated impact glass provides improved security against intruders
- Sentinel's laminated glass eliminates up to 99% of UV ray damage to your interior furnishings
- Sentinel's laminated impact glass reduces outside noise transmission into the interior of your home or property



# The Sentinel Advantage

by  Impact Resistant Windows & Doors

## Up to 30% thicker aluminum extrusions

**THEIRS**  
Thinner aluminum gauge provides less strength and sturdiness

**SENTINEL**  
Up to 30% thicker aluminum extrusions for superior strength

## Uneven sightlines

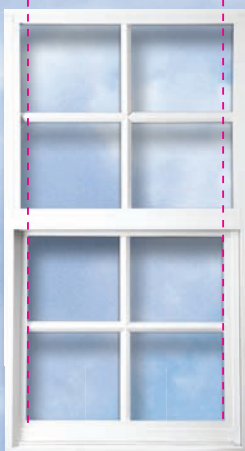

**THEIRS**  
Difference in thickness of top and bottom sash construction is less aesthetically pleasing

## Architecturally correct sightlines



**SENTINEL**  
Matching top and bottom sash sightlines offer a high-end symmetrical look to your home

## Unsightly protruding top rail



**THEIRS**  
Protruding rail that detracts from appearance

## Smooth flush appearance



**SENTINEL**  
Better aesthetics with our flush design



**THEIRS**  
Open L-frame design reduces structural integrity. Unsightly foam pads capture dirt and tend to fall off or get removed





**Larger stainless steel fasteners**



**SENTINEL**  
CGI offers superior frame construction design because we fasten our frame corners using three #10-1 ¼ inch stainless steel fasteners

**THEIRS**  
Smaller and fewer #8-1 inch screws provide less frame strength, product longevity and hurricane resistance

**Hidden balances**



**SENTINEL**  
Features hidden balances for a cleaner, neater look (most sizes)

**THEIRS**  
Exposed hardware detracts from appearance

**Captured bottom rail**



**SENTINEL**  
Superior captured bottom rail u-frame design for improved strength and protection from water infiltration

**Triple Weatherstripping**

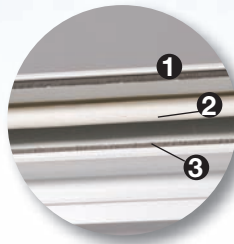

**SENTINEL**  
Triple weatherstripping at the sill creates superior energy efficient air and water infiltration protection

**THEIRS**  
One row of weatherstripping. More likely to leak resulting in energy loss and water intrusion

# Reduce energy costs with energy saving options.

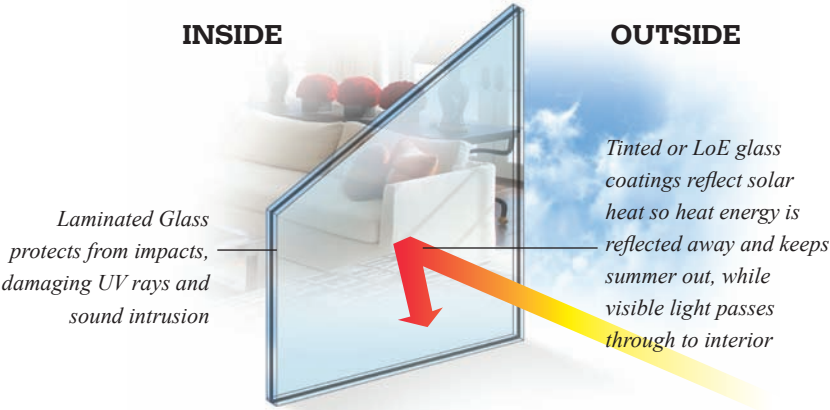

*Save on your heating and cooling bill by combining energy efficient glass choices including glass tints, LoE and insulated glass.*

Combine the advantages of impact protection and energy savings with Sentinel windows and doors. Save on your heating and cooling bill by selecting from a wide variety of energy efficient glass choices including tinted glass, LoE coatings and insulated glass. Choose your glass type based on where you live and your budget. For example, tinted laminated glass may be the most cost effective impact resistant glazing option. Consider tinted laminated for warm climates such as Florida, the Caribbean, Hawaii, and coastal areas of South Carolina, Alabama, Mississippi, and Louisiana. If you are looking for higher performance glass options, laminated glass with a LoE coating or insulated laminated glass with a LoE coating are available. These high performance glass options are perfect for





cooler climates such as North Carolina, inland sections of South Carolina, Alabama, Mississippi and Louisiana, as well as anywhere required by local building codes. Please contact a Sentinel dealer for more information.

### **Easy Retrofit**

Sentinel is custom manufactured to exact sizes within our wide range of design parameters therefore reducing on-site construction costs. In addition, Sentinel's frame depth is designed for both new construction and replacement applications resulting in faster, less intrusive installations. Uniquely designed, Sentinel products are the best choice for your remodeling project. Improve the value, energy efficiency and aesthetics of your property by selecting Sentinel windows and doors.

### **Superior Warranty Coverage**

Sentinel products are backed by our long standing comprehensive product warranty. Ask your local Sentinel dealer for details or visit our website at [www.cgiwindows.com](http://www.cgiwindows.com)





Single Hung

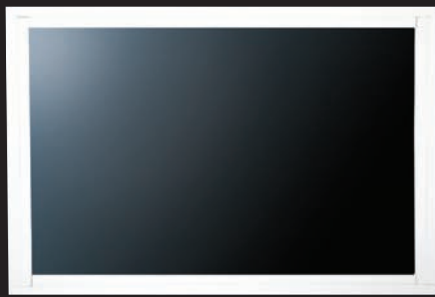

Fixed

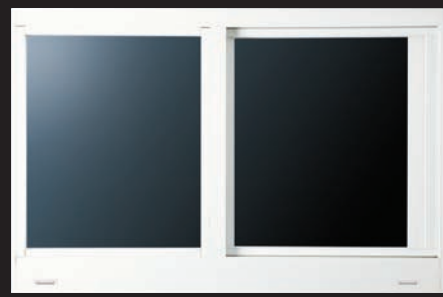

Horizontal Rolling



Casement/Project Out



Designer



French Door



Sliding Glass Door



## The closer you look, the better Sentinel looks



Egress Self Closing or Sweep Lock



Semi-Contoured Muntins

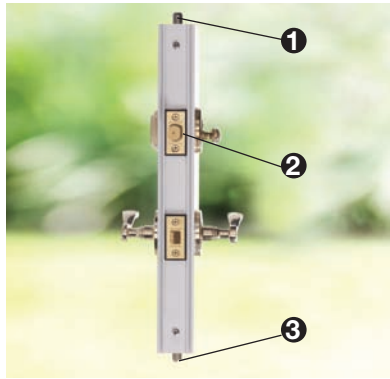

Three Point Locking System



Sliding Glass Door Mitered Corner

## Super-View™ Screen



Our Super-View™ see-through screen material provides strong construction and clearer, unobstructed views. Our screens are constructed using a sturdy extruded frame design.

Choose from a number of beautiful designer configurations

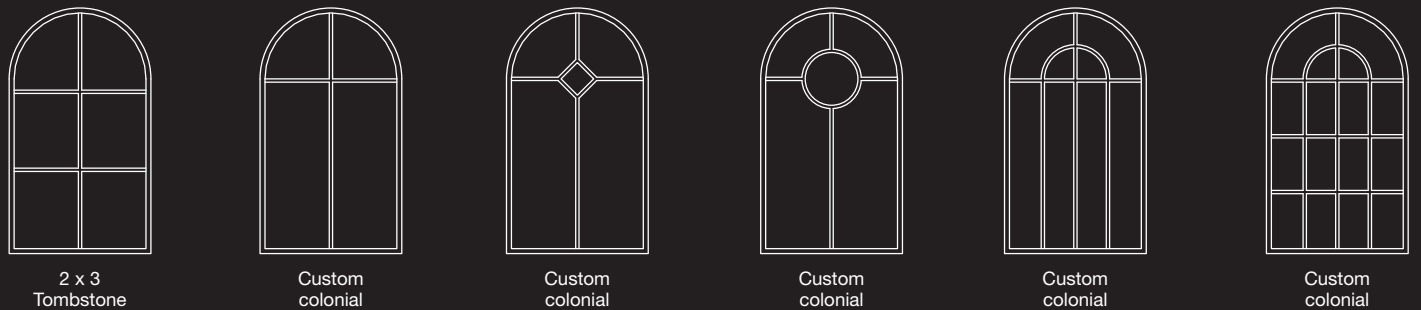
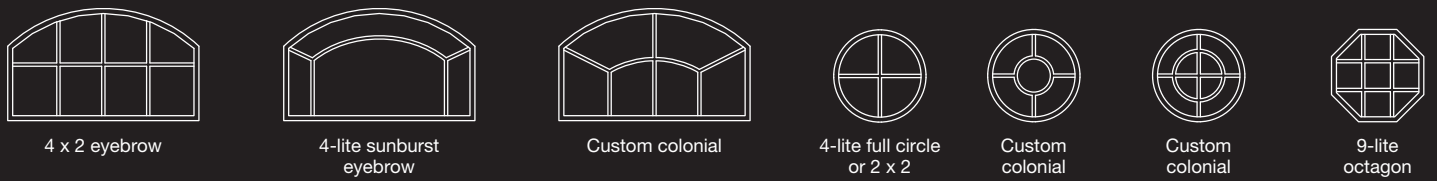
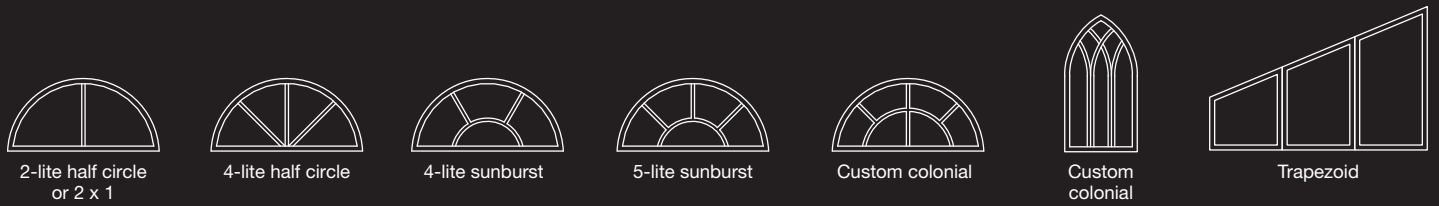
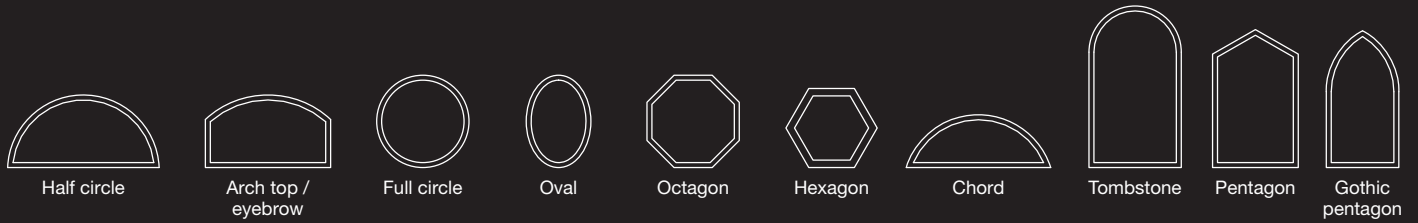



## Sentinel Products Offer Many Customizable Choices

### Frame Color

- White ESP
- Clear Anodized
- Bronze ESP

### Glass Types

- Laminated
- Insulated Laminated

### Glass Tints

- Clear
- Gray
- Dark Gray (Turtle code)
- Bronze
- Solexia Green
- Azuria Blue
- White Interlayer
- Mist (Pattern 62)
- Rain

### Glass Coatings

- Energy Efficient LoE options

### Muntin/Grid Design

- Large assortment of muntin designs

### Single Hung

- Sash bottom rail mounted egress lock standard
- Sash top rail mounted sweep lock option
- Concealed head installation screws
- Stainless steel fasteners standard
- Extruded screen frame with Super-View™ screen mesh standard

### Horizontal Rolling Window

- Two & Three panel configurations OX, XO, XOX
- Sash handle rail mounted egress lock standard
- Sash interlock rail mounted sweep lock option
- Concealed jamb anchors
- Stainless steel fasteners standard
- Extruded screen frame with Super-View™ screen mesh standard

### Casement

- Stainless steel operator standard
- Stainless steel 4 bar hinges standard
- Stainless steel fasteners
- Extruded screen frame with Super-View™ screen mesh standard

### Project Out

- Stainless steel dual arm operator standard
- Stainless steel 4 bar concealed hinges standard
- Stainless steel fasteners
- Extruded screen frame with Super-View™ screen mesh standard

### Sliding Glass Doors

- 2, 3 & 4 track configurations
- Pocketing panel options
- Exterior keyed security lock option
- Stainless steel fasteners standard
- Single & dual track extruded frame with Super-View™ screen

**Available Finishes:**

- White, Bronze and Class I Clear Anodized

**Standard Glass Colors:**

- Clear, Gray, Dark Gray (Turtle Code), Bronze, Solexia Green, Azuria Blue, White Interlayer, Mist (Pattern 62), Rain

**Glass Types:**

- 5/16" Laminated
- 3/4" Insulated Laminated

**Glass Coatings:**

- Energy efficient LoE options

**Standard Hardware:**

- Egress self closing lock (sill mounted)

**Standard Features:**

- Matching top and bottom sightlines
- Flush design
- U-framed captured bottom rail with triple weatherstripping and weeped sill
- 2 1/2" deep frame
- Hidden block and tackle balances (most sizes)
- Extruded snap-on square glazing beads
- Strong structural glazing
- Concealed head anchors
- (3) #10-1 1/4" stainless steel fasteners per corner
- Extruded screen frame with Super-View™ fiberglass mesh

**Optional Items:**

- Meeting rail mounted sweep locks
- Uneven size vent windows (Oriel)
- Flange, fin & equal leg frame options
- Additional egress self closing lock

**Optional Muntins:**

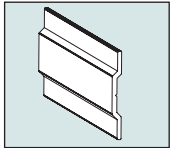

Low Profile

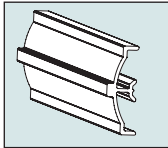

Semi-Contoured (exterior only)

**Glass Types:**



Laminated Glass



Insulated Laminated Glass

# Sentinel Single Hung Window 110

Available with Sentinel clipless mullions that are flush on the interior. Concealed balances and stainless steel package comes standard. Architecturally correct sightlines.

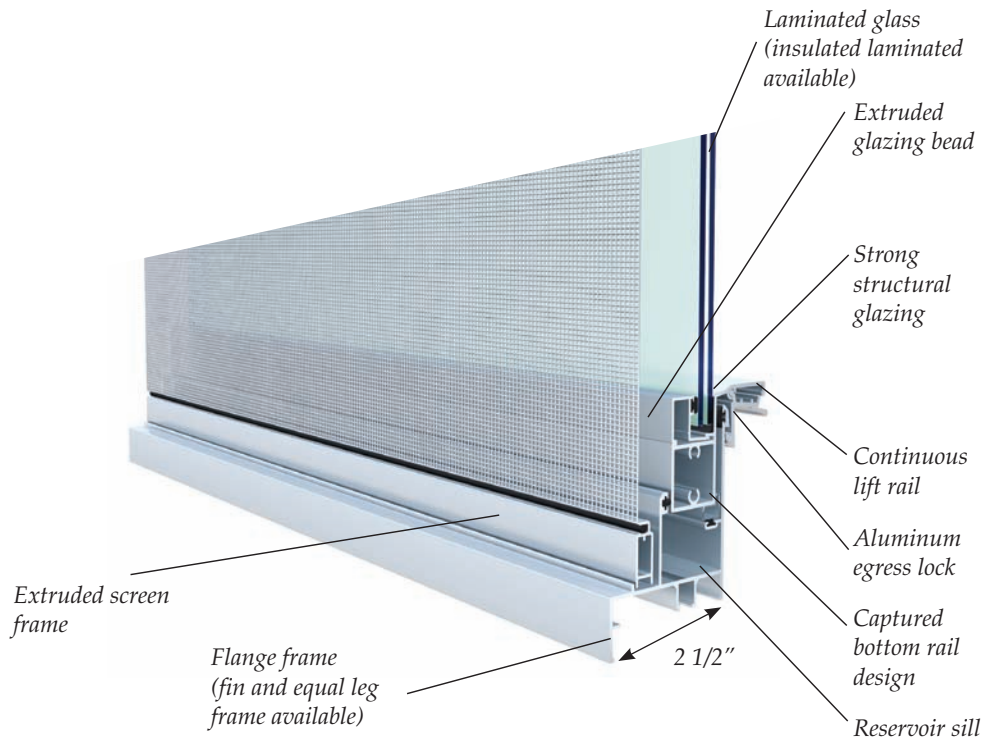



## Sentinel Single Hung Window 110

### Commodity Sizes (In inches)

Width	Height	Width	Height	Width	Height	Width	Height
19 1/8	26	26 1/2	26	37	26	53 1/8	26
19 1/8	38 3/8	26 1/2	38 3/8	37	38 3/8	53 1/8	38 3/8
19 1/8	50 5/8	26 1/2	50 5/8	37	50 5/8	53 1/8	50 5/8
19 1/8	59 1/2	26 1/2	59 1/2	37	59 1/2	53 1/8	59 1/2 e
19 1/8	63	26 1/2	63	37	63	53 1/8	63 e
19 1/8	76	26 1/2	76	37	76 e	53 1/8	76 e

All single hung windows have a 2 1/2" depth, ideal for replacement applications  
e=Meets clear opening egress requirements at 5.7 sq. ft.

### Modular Sizes (In inches)

Width	Height	Width	Height	Width	Height	Width	Height	Width	Height
24	26	32	26	40	26	44	26	48	26
24	38 3/8	32	38 3/8	40	38 3/8	44	38 3/8	48	38 3/8
24	50 5/8	32	50 5/8	40	50 5/8	44	50 5/8	48	50 5/8
24	59 1/2	32	59 1/2	40	59 1/2 e	44	59 1/2 e	48	59 1/2 e
24	63	32	63	40	63 e	44	63 e	48	63 e
24	76	32	76	40	76 e	44	76 e	48	76 e

All single hung windows have a 2 1/2" depth, ideal for replacement applications

### Performance Results

Maximum Water Resistance		12 PSF
Large Missile	53 1/8" x 76" window (Ann/Ann Glass)	+75 PSF /-75 PSF
	53 1/8" x 76" window (HS/HS Glass)	+80 PSF /-85 PSF
Forced Entry Test (AAMA 1302.5)		Passed

Small missile performance results available upon request.

### Energy Values (NFRC Approved)

Laminated		U Factor	SHGC	VT
5/16"	Clear LoE 366	1.05	0.29	.46
5/16"	Gray	1.04	0.49	.44
5/16"	Clear	1.04	0.59	.66
Insulated Laminated				
3/4"	Clear LoE 366	0.60	0.23	.47
3/4"	Clear LoE 270	0.60	0.30	.51

**Available Finishes:**

- White, Bronze and Class I Clear Anodized

**Standard Glass Colors:**

- Clear, Gray, Dark Gray (Turtle Code), Bronze, Solexia Green, Azuria Blue, White Interlayer, Mist (Pattern 62), Rain

**Glass Types:**

- 5/16" Laminated
- 3/4" Insulated Laminated

**Glass Coatings:**

- Energy efficient LoE options

**Standard Hardware:**

- Egress lock

**Standard Features:**

- Two & three panel configurations  
OX, XO, XOX
- Equal lites or 1/4-1/2-1/4 configuration
- Flush design
- Double weatherstripping and weeped sill
- 2 1/2" deep frame
- Extruded snap-on square glazing beads
- Strong structural glazing
- Concealed jamb anchor cover
- (3) #10-1 1/4" stainless steel fasteners per corner
- Extruded screen frame with Super-View™ fiberglass mesh

**Optional Items:**

- Sash interlock rail mounted sweep lock
- Flange, fin & equal leg frame options

**Optional Muntins:**

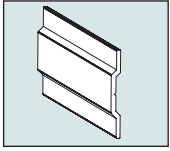

Low Profile

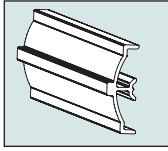

Semi-Contoured (exterior only)

**Glass Types:**



Laminated Glass



Insulated Laminated Glass

# Sentinel Horizontal Rolling Window 120

Available with Sentinel clipless mullions that are flush on the interior. Stainless steel package comes standard. Super smooth rolling action.

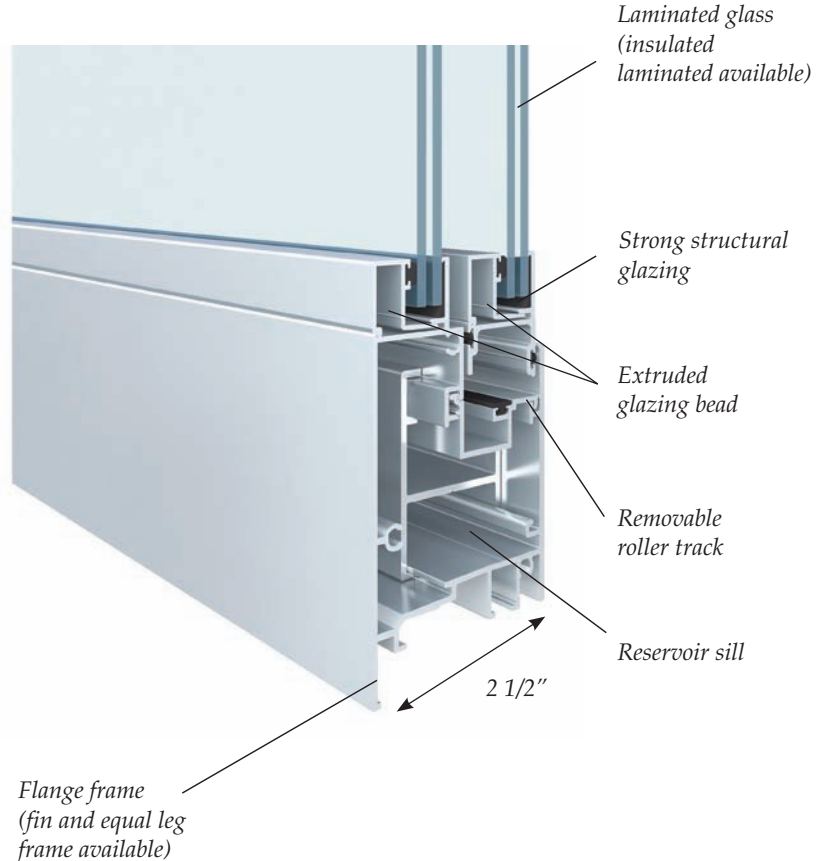
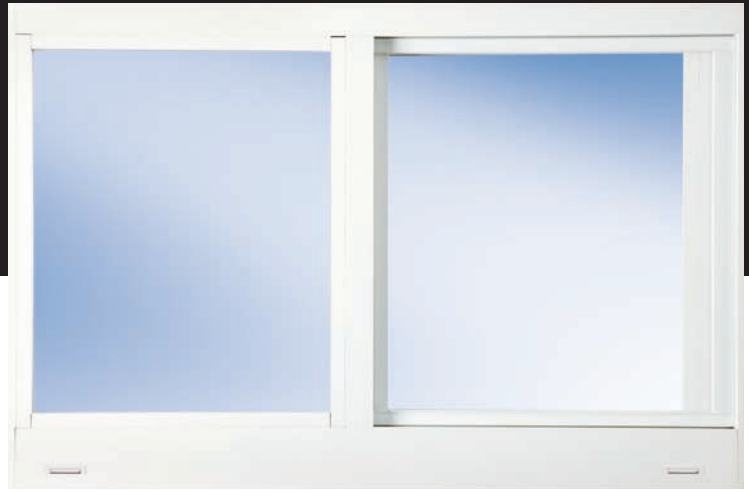



## Sentinel Horizontal Rolling Window 120\*

### Commodity Sizes XO or OX (In inches)

Width	Height	Width	Height	Width	Height	Width	Height
26 1/2	26	37	26	53 1/8	26	74	26
26 1/2	38 3/8	37	38 3/8	53 1/8	38 3/8	74	38 3/8 e
26 1/2	50 5/8	37	50 5/8	53 1/8	50 5/8 e	74	50 5/8 e
26 1/2	63	37	63	53 1/8	63 e	74	63 e

All horizontal rolling windows have a 2 1/2" depth, ideal for replacement applications  
e=Meets clear opening egress requirements at 5.7 sq. ft.

\* XOX configurations also available

### Modular Sizes XO or OX (In inches)

Width	Height	Width	Height	Width	Height	Width	Height	Width	Height	Width	Height	Width	Height
24	24	36	24	48	24	54	24	60	24	66	24	72	24
24	26	36	26	48	26	54	26	60	26	66	26	72	26
24	36	36	36	48	36	54	36	60	36	66	36	72	36
24	38 3/8	36	38 3/8	48	38 3/8	54	38 3/8	60	38 3/8	66	38 3/8	72	38 3/8
24	48	36	48	48	48	54	48	60	48	66	48	72	48
24	50 5/8	36	50 5/8	48	50 5/8	54	50 5/8 e	60	50 5/8 e	66	50 5/8 e	72	50 5/8 e
24	54	36	54	48	54	54	54 e	60	54 e	66	54 e	72	54 e
24	60	36	60	48	60	54	60 e	60	60 e	66	60 e	72	60 e
24	63	36	63	48	63	54	63 e	60	63 e	66	63 e	72	63 e

All horizontal rolling windows have a 2 1/2" depth, ideal for replacement applications

### Performance Results

Maximum Water Resistance		12 PSF
Large Missile	2 panel 74" x 63" window (Ann/Ann Glass)	+65 PSF/-65 PSF
	3 panel 111" x 63" window (Ann/Ann Glass)	+65 PSF/-65 PSF
	2 panel 74" x 63" window (HS/HS Glass)*	+80 PSF/-90 PSF
	3 panel 111" x 63" window (HS/HS Glass)*	+80 PSF/-90 PSF
Forced Entry Test (AAMA 1302.5)		Passed

Small missile performance results available upon request.

\* Fin frame windows limited to +80 PSF/-80 PSF

### Energy Values (NFRC Approved)

Laminated		U Factor	SHGC	VT
5/16"	Clear LoE 366	1.06	0.29	.45
5/16"	Gray	1.03	0.48	.43
5/16"	Clear	1.03	0.57	.64
Insulated Laminated				
3/4"	Clear LoE 366	0.61	0.23	.46
3/4"	Clear LoE 270	0.61	0.29	.50

**Available Finishes:**

- White, Bronze and Class I Clear Anodized

**Standard Glass Colors:**

- Clear, Gray, Dark Gray (Turtle Code), Bronze, Solexia Green, Azuria Blue, White Interlayer, Mist (Pattern 62), Rain

**Glass Types:**

- 7/16" Laminated
- 1" Insulated Laminated

**Glass Coatings:**

- Energy efficient LoE options

**Standard Accessories:**

- (2) #10-1 1/4" stainless steel fasteners per corner
- Extruded snap-on square glazing beads
- 2 1/2" deep frame
- Strong structural glazing
- Fastener covers

**Designer Fixed Windows:**

- Half circle
- Arch top/eyebrow
- Full circle
- Octagon
- Hexagon
- Chord
- Tombstone
- Trapezoid
- Pentagon
- Gothic pentagon

**Optional Items:**

Flange, fin & equal leg frame options

**Optional Muntins:**

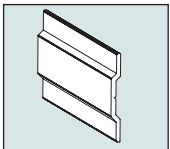

Low Profile

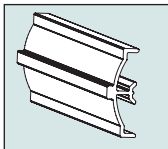

Semi-Contoured (exterior only)

**Glass Types:**



Laminated Glass



Insulated Laminated Glass

# Sentinel Fixed Window 130

Available with Sentinel clipless mullions that are flush on the interior. Installation screw covers and stainless steel package comes standard. Up to 33 sq ft.

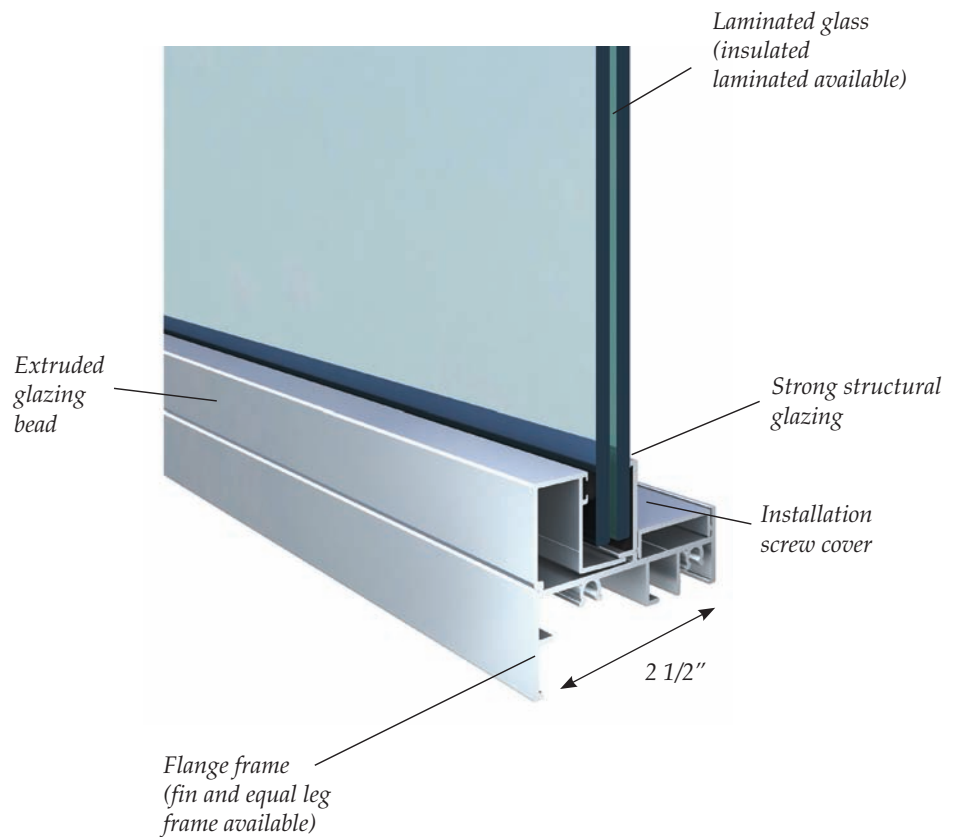
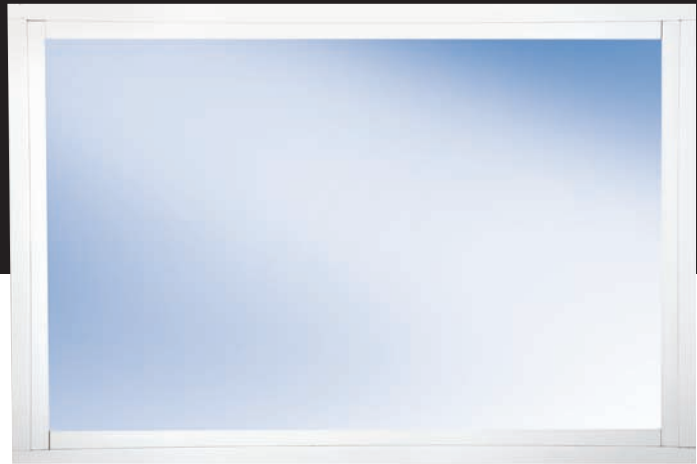

## Sentinel Fixed Window 130

### Rectangular Fixed Sizes (In inches)

- All fixed windows have a 2 1/2" depth, ideal for replacement applications
- Equal Leg and Fin frame max area is 32 Sq Ft

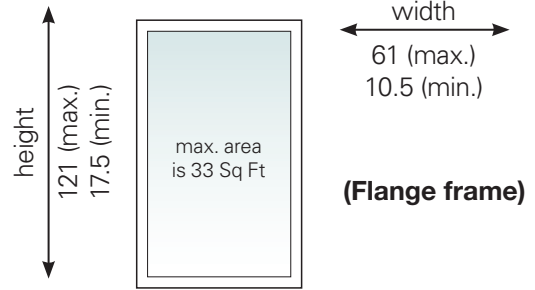

### Performance Results

Maximum Water Resistance		12 PSF
Large Missile	49" x 97" window (Ann/HS Glass)	+60 PSF /-60 PSF
	49" x 97" window (HS/HS Glass)	+80 PSF /-80 PSF

Small missile performance results available upon request.

### Energy Values (NFRC Approved)

Laminated		U Factor	SHGC	VT
7/16"	Clear LoE 366	1.00	0.33	.51
7/16"	Gray	0.96	0.49	.42
7/16"	Clear	0.96	0.63	.74
Insulated Laminated				
1"	Clear LoE 366	0.42	0.25	.53
1"	Clear LoE 270	0.42	0.32	.57



**Available Finishes:**

- White, Bronze and Class I Clear Anodized

**Standard Glass Colors:**

- Clear, Gray, Dark Gray (Turtle Code), Bronze, Solexia Green, Azuria Blue, White Interlayer, Mist (Pattern 62), Rain

**Glass Types:**

- 5/16" Laminated
- 3/4" Insulated Laminated

**Glass Coatings:**

- Energy efficient LoE options

**Standard Hardware:**

- Single Stainless Steel arm roto operator and nesting crank handle
- Stainless steel operator track
- Pair of stainless steel four bar concealed hinges
- Pair of locks (one lock on window under 30" high)
- Pair of stainless steel keepers for above locks
- Snubber blocks
- Small operator on units less than 24", Large operator on units 24" or more

**Standard Features:**

- Extruded screen frame with Super-View™ mesh
- Extruded snap-on square glazing beads
- Stainless steel assembly screws and corner keys
- Double weatherstripping
- 1/2" Exterior flange frame
- 2" Deep frame

**Optional Items:**

- Connecting lock bar for egress windows
- Custodial type locks (for institutional use)
- Limit Opening Devices
- Hinges with washability feature (for high-rise use)
- Equal leg frame

**Optional Muntins:**

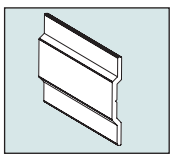

Low Profile

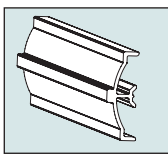

Semi-Contoured (exterior only)

**Glass Types:**



Laminated Glass



Insulated Laminated Glass

# Sentinel Casement Window 238SN

Stainless steel package comes standard including operator and hinges complementing the attractive architectural sightlines.

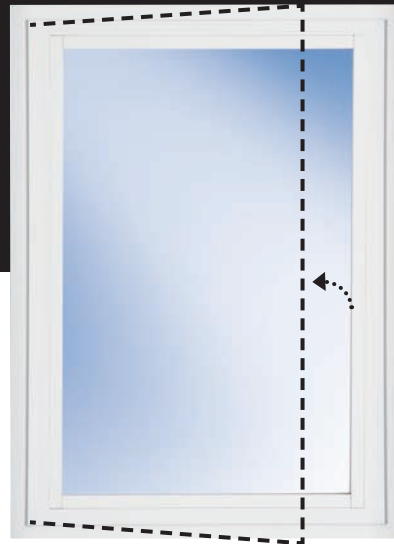

Opens outward from the side

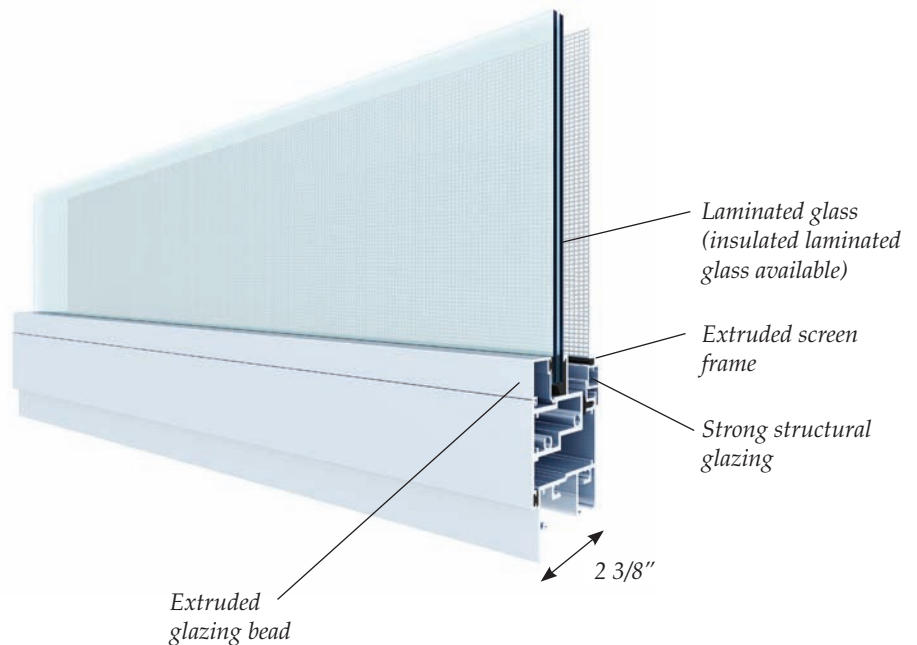

## Sentinel Casement Window 238SN

### Commodity Sizes (In inches)

Width	Height	Width	Height	Width	Height
19 1/8	17	26 1/2	17	37	17
19 1/8	26	26 1/2	26	37	26
19 1/8	38 3/8	26 1/2	38 3/8	37	38 3/8 e
19 1/8	50 5/8	26 1/2	50 5/8 e	37	50 5/8 e
19 1/8	63	26 1/2	63 e	37	63 e
19 1/8	72	26 1/2	72 e		

e=Meets clear opening egress requirements at 5.7 sq. ft.

### Custom Sizes (In inches)

Width		Height	
Minimum available	18	Minimum available	17
Maximum available	42	Maximum available	84

Maximum over-all window area is 16.34 sq ft

### Modular Sizes (In inches)

Width	Height	Width	Height	Width	Height	Width	Height	Width	Height	Width	Height
20	24	24	24	28	24	30	24	32	24	36	24
20	30	24	30	28	30	30	30	32	30	36	30
20	36	24	36	28	36	30	36	32	36	36	36 e
20	42	24	42	28	42	30	42 e	32	42 e	36	42 e
20	48	24	48	28	48 e	30	48 e	32	48 e	36	48 e
20	54	24	54	28	54 e	30	54 e	32	54 e	36	54 e
20	60	24	60	28	60 e	30	60 e	32	60 e	36	60 e
20	66	24	66	28	66 e	30	66 e	32	66 e		
20	72	24	72	28	72 e	30	72 e	32	72 e		
20	78	24	78	28	78 e						
20	84	24	84								

e=Meets clear opening egress requirements at 5.7 sq. ft.

### Performance Results

Maximum Water Resistance		16.5 PSF
Large Missile	20" x 36" window (Ann/Ann Glass)	+110/-194.3 PSF
	37" x 63" window (Ann/Ann Glass)	+/-60 PSF
Forced Entry Test (AAMA 1302.5)		Passed

### Energy Values (NFRC Approved)

Laminated		U Factor	SHGC	VT
5/16"	Gray	1.04	0.44	.39
5/16"	Clear	1.04	0.53	.59
Insulated Laminated				
3/4"	Clear LoE 366	0.63	0.21	.42
3/4"	Clear LoE 270	0.63	0.27	.46

**Available Finishes:**

- White, Bronze and Class I Clear Anodized

**Standard Glass Colors:**

- Clear, Gray, Dark Gray (Turtle Code), Bronze, Solexia Green, Azuria Blue, White Interlayer, Mist (Pattern 62), Rain

**Glass Types:**

- 5/16" Laminated
- 3/4" Insulated Laminated

**Glass Coatings:**

- Energy efficient LoE options

**Standard Hardware:**

- Dual Stainless Steel arm roto operator and crank handle
- Stainless steel operator track
- Pair of stainless steel four bar concealed hinges
- Pair of locks
- Pair of stainless steel keepers for above locks
- Snubber blocks
- Small arm operator on units less than 32", Large arm operator on units 32" or more

**Standard Features:**

- Extruded screen frame with Super-View™ mesh
- Extruded snap-on square glazing beads
- Stainless steel assembly screws and corner keys
- Double weatherstripping
- 1/2" Exterior flange frame
- 2" Deep frame

**Optional Items:**

- Custodial type locks (for institutional use)
- Limit Opening Devices
- Collapsible crank handle
- Equal leg frame

**Optional Muntins:**

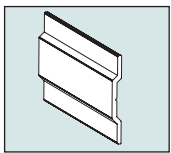

Low Profile

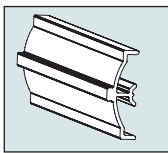

Semi-Contoured (exterior only)

**Glass Types:**



Laminated Glass



Insulated Laminated Glass

# Sentinel Project Out Window 238SN

Stainless steel package comes standard including operator and hinges complementing the attractive architectural sightlines.



Opens outward from the bottom

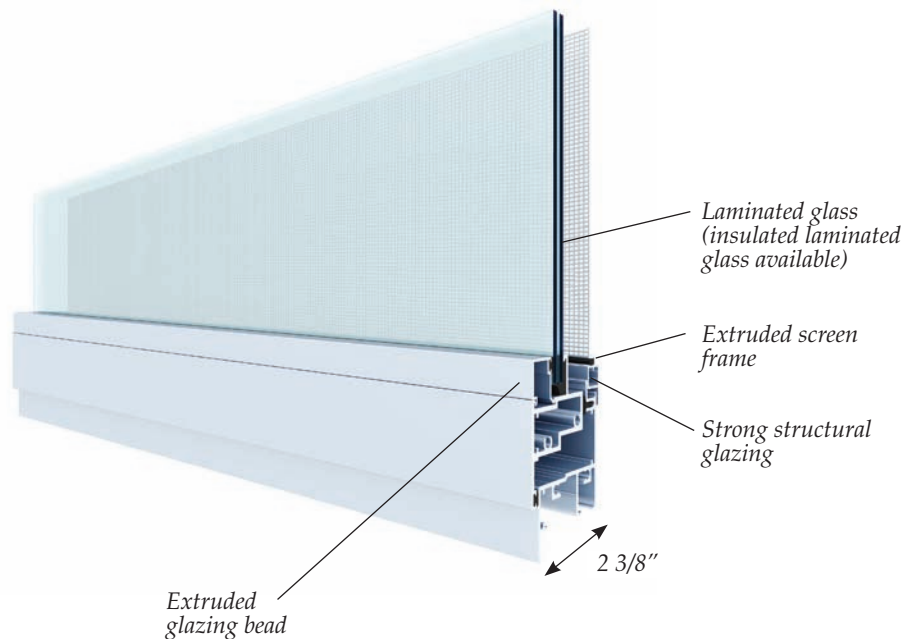



# Sentinel Project Out Window 238SN

## Commodity Sizes (In inches)

Width	Height	Width	Height	Width	Height
19 1/8	17	26 1/2	17	37	17
19 1/8	26	26 1/2	26	37	26
19 1/8	38 3/8	26 1/2	38 3/8	37	38 3/8
19 1/8	50 5/8	26 1/2	50 5/8	37	50 5/8
19 1/8	63	26 1/2	63	37	63
19 1/8	72	26 1/2	72		

## Custom Sizes (In inches)

Width		Height	
Minimum available	18	Minimum available	17
Maximum available	84	Maximum available	84

Maximum over-all window area is 16.34 sq ft

## Modular Sizes (In inches)

WxH	WxH	WxH	WxH	WxH	WxH	WxH	WxH	WxH	WxH	WxH	WxH	WxH
20x24	24x24	28x24	30x24	32x24	36x24	40x24	42x24	48x24	54x24	60x24	66x24	72x24
20x30	24x30	28x30	30x30	32x30	36x30	40x30	42x30	48x30	54x30	60x30	66x30	72x30
20x36	24x36	28x36	30x36	32x36	36x36	40x36	42x36	48x36	54x36	60x36		
20x42	24x42	28x42	30x42	32x42	36x42	40x42	42x42	48x42	54x42			
20x48	24x48	28x48	30x48	32x48	36x48	40x48	42x48	48x48				
20x54	24x54	28x54	30x54	32x54	36x54	40x54	42x54					
20x60	24x60	28x60	30x60	32x60	36x60							
20x66	24x66	28x66	30x66	32x66								
20x72	24x72	28x72	30x72	32x72								
20x84	24x84											

All window dimensions shown are tip to tip of exterior 1/2" flange on frame. Do not use Project Out windows where Egress (Emergency Escape) is required. Use of small arm operator will limit window opening (ventilation) to 2 3/4". Use of large arm operator will limit window opening (ventilation) to 8".

## Performance Results

Maximum Water Resistance		16.5 PSF
Large Missile	24" x 36" window (Ann/Ann Glass)	+110/-161.9 PSF
	37" x 63" window (Ann/Ann Glass)	+/-60 PSF
Forced Entry Test (AAMA 1302.5)		Passed

## Energy Values (NFRC Approved)

Laminated		U Factor	SHGC	VT
5/16"	Gray	1.07	0.44	.39
5/16"	Clear	1.07	0.53	.59
Insulated Laminated				
3/4"	Clear LoE 366	0.63	0.21	.42
3/4"	Clear LoE 270	0.63	0.27	.46

90 degree and 135 degree options now available

## Sentinel Sliding Glass Door 150

Now with concealed fasteners, 2 point lock and updated door stop. Stainless steel package comes standard and the 4.75" 2-track depth allows for easy retrofit install. Available in 2, 3 or 4 track configurations and pockets.

### Available Finishes:

- White, Bronze and Class I Clear Anodized

### Standard Glass Colors:

- Clear, Gray, Dark Gray (Turtle Code), Bronze, Solexia Green, Azuria Blue, White Interlayer, Mist (Pattern 62), Rain

### Glass Types:

- 7/16" Laminated
- 1" Insulated Laminated

### Glass Coatings:

- Energy efficient LoE options

### Standard Hardware:

- Interior lock and handle
- Stainless steel rollers
- White, Bronze or Gray handles

### Standard Features:

- 2, 3 & 4 track and pocketed configurations
- 4 3/4" deep frame on 2 track
- 6" deep frame on 3 track
- 7 3/4" deep frame on 4 track
- Mitered decorative interior corners
- Stainless steel fasteners
- Heavy duty extruded screen frame with Super-View™ fiberglass mesh
- 2-point lock
- Concealed installation screws

### Optional Items:

- Exterior keyed security lock
- Dual track extruded screen frame with Super-View™ fiberglass mesh for use with 3 & 4 track configurations

### Optional Muntins:

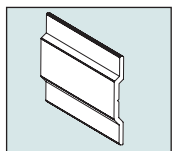

Low Profile

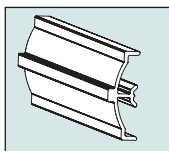

Semi-Contoured (exterior only)

### Glass Types:



Laminated Glass



Insulated Laminated Glass

### 90 degree and 135 degree corner doors:

- 2, 3, 4 Track Options
- Max DP: +/- 60 PSF
- Two Lock sets for a total of 4 lock points



NEW HANDLES

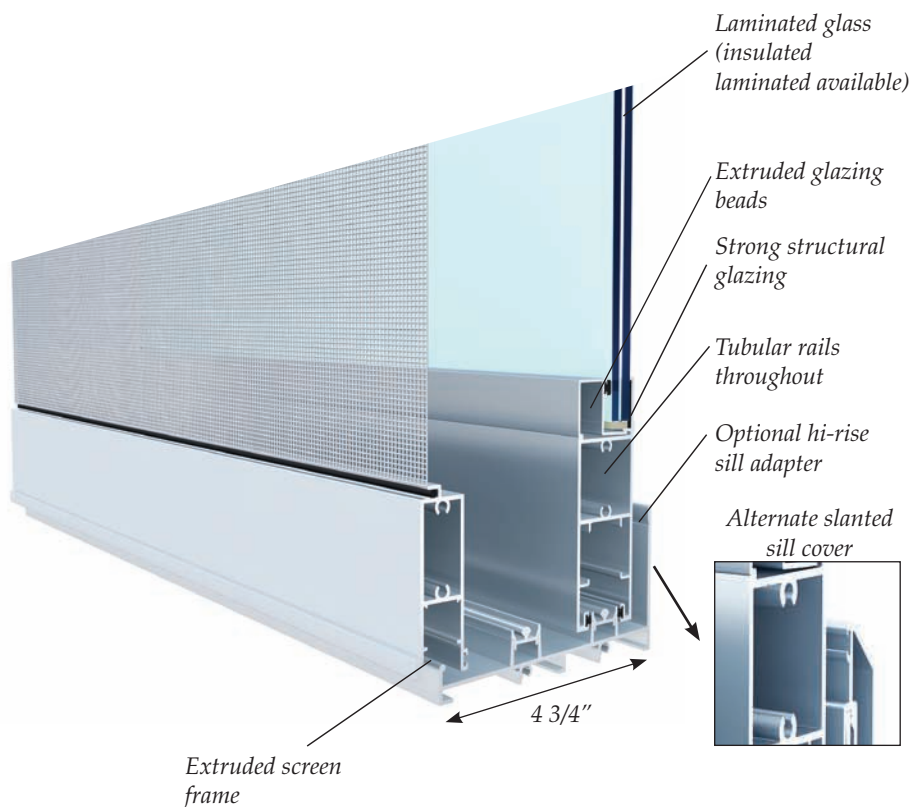

## Sentinel Sliding Glass Door 150\*

### Door Sizes

**Sentinel 6'8", 8' and 10' Sliding Glass Door Sizes** (80", 96" and 120" frame height)

2 Track Configuration	Call Width	Frame Width	3 Track Configuration	Call Width	Frame Width	4 Track Configuration	Call Width	Frame Width						
OX,XO, XX-R, XX	4-0	48"	XXX,XXO XXX-R,OXX	7-6	88 1/16"	XXXO, OXXX, XXXX, XXXXR	10-0	116 1/16"						
	5-0	60"		9-0	106 1/16"		12-0	140 1/16"						
	6-0	72"		12-0	142 1/16"		16-0	188 1/16"						
	8-0	96"					18-0	212 1/16"						
OXO,OXO-R	9-0	108 3/8"	OXXXXO, XXXXXX	15-0	174 5/8"	OXXXXXXO, XXXXXXX	20-0	230 9/16"						
	12-0	144 3/8"					24-0	278 9/16"						
OXXO,XXXX	10-0	118 7/16"					18-0	210 5/8"	32-0	374 9/16"				
	12-0	142 7/16"									24-0	282 5/8"	36-0	422 9/16"
	16-0	190 7/16"												

\* Pocket configurations available

### Performance Results

Maximum Water Resistance	Without waterbar adapter	9 PSF
	With waterbar adapter	12 PSF
Large Missile	4' x 8' Panel (Ann/HS Glass)	+60 PSF /-60 PSF
	4' x 8' Panel (HS/HS Glass)	+80 PSF /-80 PSF
	4' x 10' Panel (Ann/HS Glass)	+60 PSF /-60 PSF
Forced Entry Test (AAMA 1302.5)		Passed

### Energy Values (NFRC Approved)

Laminated		U Factor	SHGC	VT
7/16"	Clear LoE 366	1.02	0.29	.44
7/16"	Gray	1.03	0.43	.37
7/16"	Clear	1.03	0.56	.65
Insulated Laminated				
1"	Clear LoE 366	0.56	0.22	.46
1"	Clear LoE 270	0.56	0.28	.50



**Available Finishes:**

- White, Bronze and Class I Clear Anodized

**Standard Glass Colors:**

- Clear, Gray, Dark Gray (Turtle Code), Bronze, Solexia Green, Azuria Blue, White Interlayer, Mist (Pattern 62), Rain

**Glass Types:**

- 7/16" Laminated
- 1" Insulated Laminated

**Glass Coatings:**

- Energy efficient LoE options

**Standard Hardware:**

- Patented concealed 3 point lock
- Aluminum hinges

**Standard Features:**

- Extruded snap-on square glazing beads
- 4" deep frame
- Fastener covers
- Triple weatherstripping
- Outswing configuration
- Square or slanted sill cover

**Optional Items:**

- Brushed Satin, Tuscan Bronze or Polished Brass levers
- Free-Standing and Self-Mating Sidelites

**Optional Muntins:**

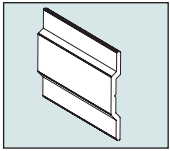

Low Profile

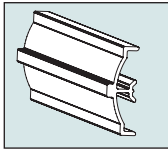

Semi-Contoured (exterior only)

**Glass Types:**



Laminated Glass

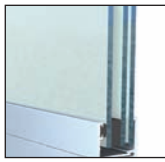

Insulated Laminated Glass

# Sentinel French Door 160

Comes standard with CGI patented 3 point lock and stainless steel package. Available with self-mating sidelites. 4" frame depth allows for easy retrofit install. Slanted or square sill covers

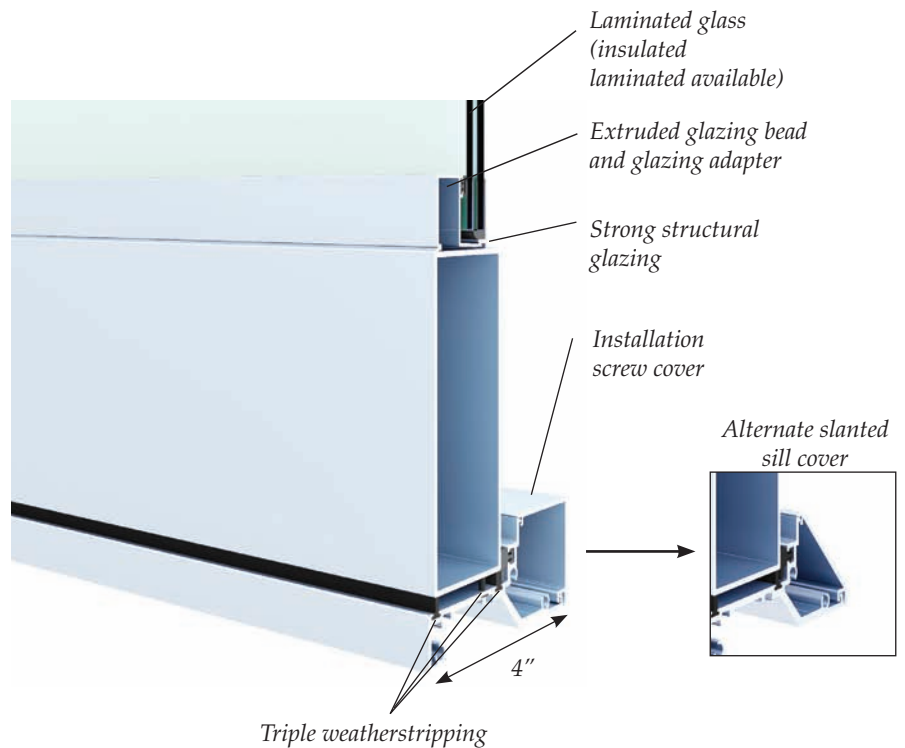

## Sentinel French Door 160

### Door Sizes (In inches)

#### Single

Code Size	6' 8"		Code Size	8' 0"	
	Width	Height		Width	Height
2668	31 1/4	80	2680	31 1/4	96
2868	33 1/4	80	2880	33 1/4	96
3068	37 1/4	80	3080	37 1/4	96

#### Double

Code Size	6' 8"		Code Size	8' 0"	
	Width	Height		Width	Height
4068	48	80	4080	48	96
5068	60	80	5080	60	96
5468	64	80	5480	64	96
6068	72	80	6080	72	96

### Free-Standing or Self-Mating Sidelites (In inches)

Width	6' 8"	Height	Width	8' 0"	Height
12		80	12		96
18		80	18		96
24		80	24		96
30		80	30		96
33		80	33		96
36		80	36		96
37 1/8		80	*37 1/8		96

\* Free-Standing Sidelite only

### Performance Results

Maximum Water Resistance		12 PSF
Large Missile	3' x 8' Panel (Ann/Ann Glass)	+80 PSF /-80 PSF
Forced Entry Test (AAMA 1302.5)		Passed

### Energy Values

Laminated		Single Door/ Pair of Door			Self-Mating/ Free-Standing Sidelite		
		U Factor	SHGC	VT	U Factor	SHGC	VT
7/16"	Clear LoE 366	1.03	.24	.32	1.04	.28	.41
7/16"	Clear	1.03	.43	.47	1.03	.52	.59
7/16"	Gray	1.03	.34	.26	1.03	.41	.33
<b>Insulated Laminated</b>							
1"	Clear LoE 366	.69	.19	.33	.59	.22	.42
1"	Clear LoE 270	.69	.23	.36	.59	.27	.45

**Available Finishes:**

- White, Bronze and Class I Clear Anodized

**Standard Glass Colors:**

- Clear, Gray, Dark Gray (Turtle Code)
- Bronze, Solexia Green, Rain White
- Interlayer, Mist (Pattern 62)

**Glass Types:**

- 5/16" Laminated (Window)
- 7/16" Laminated (Door)
- 3/4" Insulated Laminated (Window)
- 1" Insulated Laminated (Door)

**Glass Coatings:**

- Energy efficient LoE options

**Standard Hardware:**

- Patented concealed 3-point lock
- Aluminum hinges

**Standard Features:**

- Extruded snap-on square glazing beads
- 4.5" deep frame
- Fastener covers
- Triple weatherstripping
- Inswing or Outswing configuration

**Optional Items:**

- Brushed Satin, Tuscan Bronze or Polished Brass levers
- Muntins-Grille between glass or Double applied
- Extruded aluminum screen

**Details:**

- Max single hung size: 30 3/8" x 50 5/8"
- Max panel size 42" x 102"
- Bottom aluminum panel also available

**Optional Muntins:**

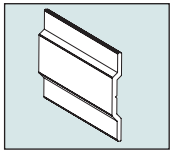

Low Profile

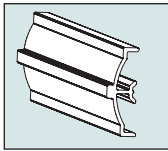

Semi-Contoured (exterior only)

**Glass Types:**



Laminated Glass



Insulated Laminated Glass

# Sentinel Balcony Breeze Door 165

Available in inswing and outswing configurations, includes CGI's patented 3-point lock and stainless steel package along with an integrated single hung within the door panel.

The single hung can be located either at the top or bottom of the door with the option for aluminum or glass in the other half. The 4.5" frame depth allows for easy installation whether new or retrofit application.

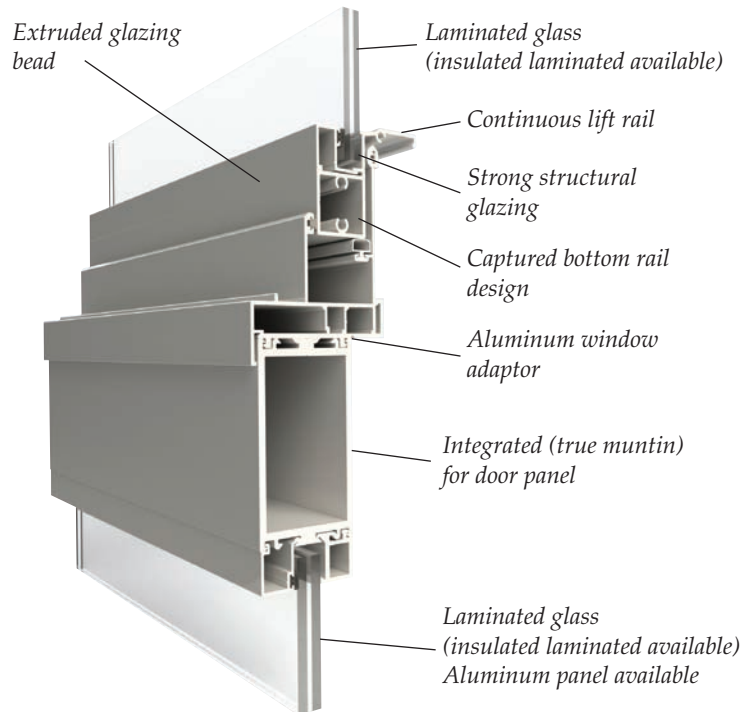

## Sentinel Balcony Breeze Door 165

### Door Sizes (In inches)

6'8"			8'0"		
CODE SIZE	WIDTH	HEIGHT	CODE SIZE	WIDTH	HEIGHT
2668	32 9/16"	80 3/4"	2680	32 9/16"	96 3/4"
2868	34 9/16"	80 3/4"	2880	34 9/16"	96 3/4"
3068	38 9/16"	80 3/4"	3080	38 9/16"	96 3/4"
Max Panel Size 42" x 102"					

### Performance Results

Maximum Water Resistance		13.5 PSF
Large Missile	42"x102" Panel (HS/HS Glass)	+ 90 PSF/ -110 PSF
Forced Entry Test (AAMA 1302.5)		Passed





**Impact Resistant  
Windows & Doors**  
WE'RE STRONGER™

CGI Windows and Doors, Inc.  
10100 NW 25th Street  
Miami, FL 33172

800.442.9042  
Office: 305.593.6590  
Fax: 305.593.6592

E-mail: [inquiries@cgiwindows.com](mailto:inquiries@cgiwindows.com)  
[www.cgiwindows.com](http://www.cgiwindows.com)



# LIMITED WARRANTY

## WHAT THIS LIMITED WARRANTY COVERS

CGI Windows and Doors (CGI), warrants to the original residential homeowner that any CGI manufactured product shall be free of material defects in manufacturing and/or materials for the applicable period specified in the tables below. This limited warranty applies to the products under normal use and service, subject to the conditions, exclusions and limitations described in this limited warranty, and for only so long as the original owner owns and resides in the home where the products are installed, subject to the limited transferability exception described in the paragraph below entitled "Transferability."

**CGI'S LIABILITY UNDER THIS LIMITED WARRANTY SHALL BE LIMITED TO THE REPAIR OR, AT CGI'S OPTION, REPLACEMENT OF NONCONFORMING GOODS OR PARTS. CGI SHALL NOT BE RESPONSIBLE FOR ANY LABOR OR DELIVERY COSTS INCURRED IN REPAIRING OR REPLACING THE PRODUCTS, OR ANY INCIDENTAL OR CONSEQUENTIAL DAMAGES THAT MAY ARISE OUT OF A CLAIM FOR BREACH OF THIS WARRANTY, INCLUDING WITHOUT LIMITATION, ANY WATER OR OTHER DAMAGES TO CEILINGS, WALLS, FLOORS, ELECTRONICS OR APPLIANCES WITHIN A RESIDENCE.**

## WHAT THIS LIMITED WARRANTY DOES NOT COVER: EXCLUSIONS

This limited warranty covers only those manufacturing and material defects as specified herein and **does not apply to, cover or include** defects or damages attributable to or caused by:

Improper installation, improper storage, improper application or use, failure to adhere to CGI's recommended cleaning and other product care and maintenance instructions, improper maintenance or cleaning, normal weathering, corrosive or otherwise abnormal environments, condensation (except as described in the section below entitled "Insulating Glass Unit"), accident, fire, flood, acts of God, multiple hurricanes, water intrusion, including but not limited to water intrusion caused by wind-driven rain due to high wind events, vandalism, riot or civil disorder, building settlement, excessive building movement or structural failures of walls or foundations, localized heat which causes excessive temperature differentials over glass surface edges, aluminum components having direct contact with a copper treated wood, such as Alkaline Copper Quaternary (ACQ), naturally occurring changes such as tarnish, corrosion, oxidization, or discoloration of hardware finishes or component parts, occurrences beyond CGI's control.

This limited warranty shall be null and void if harmful solvents are used to clean the product; or if any portion of the product is painted or coated in any way at any time after the product leaves CGI's factory; or if any other "aftermarket" products, such as window films, are applied to the CGI product.

Caulking is used on some installations to seal the frames (or trim package) against water or air penetration. Caulking is not considered a part of the CGI product and, therefore, is not covered under this warranty. Caulking is a maintenance responsibility of the owner.

## YOUR LIMITED REMEDIES IF CGI'S PRODUCT DOES NOT CONFORM TO THIS LIMITED WARRANTY

**CGI'S SOLE RESPONSIBILITY UNDER THIS WARRANTY IS LIMITED TO PROVIDING COMPONENTS OR PARTS NECESSARY TO REPAIR OR, AT CGI'S OPTION, REPLACE THE PRODUCTS COVERED BY THIS WARRANTY, FREE-OF-CHARGE OR AT A PRORATED PRICE PER THE GUIDELINES OF THIS WARRANTY THAT ARE SET FORTH IN THE TABLES BELOW. CGI SHALL NOT BE RESPONSIBLE FOR ANY LABOR OR DELIVERY COSTS INCURRED IN REPAIRING OR REPLACING THE PRODUCTS OR ANY INCIDENTAL OR CONSEQUENTIAL DAMAGES THAT MAY ARISE OUT OF A CLAIM FOR BREACH OF THIS WARRANTY.**

**THE ORIGINAL WARRANTY PERIOD SHALL NOT BE EXTENDED BY SUCH REPAIR OR REPLACEMENT.**

**REPLACEMENT PRODUCTS MAY NOT MATCH THE COLOR OF THE ORIGINAL PRODUCT, OR THE COLOR OF THE REMAINING WINDOWS AND DOORS IN THE HOME, AS COLOR MAY VARY DUE TO AGE, WEATHERING, DYE LOT DIFFERENCES OR OTHER FACTORS. CGI WILL NOT BE RESPONSIBLE OR LIABLE FOR ANY SUCH COLOR DIFFERENCES ASSOCIATED WITH ANY REPLACEMENT PRODUCT, AND WILL NOT BE REQUIRED TO HAVE THE REPLACEMENT PRODUCT "MATCH" THE COLOR OF THE ORIGINAL PRODUCT THAT IS BEING REPLACED, OR ANY OF THE WINDOWS OR DOORS THAT REMAIN IN THE HOME.**

CGI reserves the right to discontinue or change the design and specification of any product it manufactures. Should the component of the product originally installed not be available, CGI shall have the right to substitute such part determined by CGI to be of equal quality and performance.

**THIS WARRANTY COVERS ONLY THOSE CGI PRODUCTS LISTED BELOW THAT ARE INSTALLED IN OWNER-OCCUPIED RESIDENTIAL HOMES. THE WARRANTY PERIODS LISTED IN THE TABLE BELOW BEGIN ON THE DATE CGI DELIVERS PRODUCT TO OUR CUSTOMER'S SPECIFIED LOCATION.**

	<b>Sparta by CGI®</b> Series 4100A	<b>Sentinel</b> Series 100/238SN	<b>Targa</b> Series 7000
<b>Frame</b>	Limited Lifetime	Limited Lifetime	Limited Lifetime
<b>Frame Finish</b>	10 years	20 years on 2605 10 years on all other finishes	Limited Lifetime, 10 years on colored / laminated finishes
<b>Hardware, Screens and Moving Parts</b>	10 years	10 years	Limited Lifetime
<b>Insulating Glass</b>	Not applicable	0-25 years: 100% 26 years+: 50% of glass price	0-25 years: 100% 26 years+: 50% of glass price
<b>Laminated Glass</b>	5 years	10 years	10 years
<b>Stress Cracks</b>	1 year	1 year	1 year
<b>Transferable</b>	1 time	Unlimited	Unlimited
<b>Residential Intruder Protection</b>	Excluded	Included	Included

## IMPORTANT COVERAGE INFORMATION:

### Frame

Aluminum components are warranted to be free of defects in materials and workmanship. It is typical for anodized products to have color variation and processing marks that occur during manufacturing. These are not considered defects or covered under the warranty. This limited warranty is null and void if any aluminum component has direct contact with a copper treated wood, such as Alkaline Copper Quaternary (ACQ).

The vinyl components of the frame/sash members are warranted against defects resulting from blistering, chipping, cracking, peeling, corroding or pitting. Colored or laminated exterior and interior finishes are warranted against peeling, blistering or excessive color changes. This limited warranty is null and void if damage is caused by harmful cleaners or other chemical or environmental factors, or by any of the other warranty exclusions set forth herein, including exclusions described above.

### Hardware, Screen and Moving Parts

CGI warrants that mechanical operation of hardware, screen, and moving components will be free of defects in material and workmanship for the applicable warranty period described in the table above. This limited warranty excludes normal wear and tear and naturally occurring changes such as tarnish, corrosion, oxidization or discoloration of hardware finishes or component parts, as well as any of the other warranty exclusions set forth herein, including the exclusions described above.

### Glass

Glass has prevalent characteristics such as distortion, bubbles, discolorations, blurs, debris, and scratches. These types of characteristics are expected, and are excluded from this limited warranty, as they are inherent qualities that meet or exceed standard specifications for flat glass ASTM C 1036, heat treated flat glass ASTM C 1048, and laminated architectural flat glass ASTM C 1172. Heat strengthened or tempered glass may have distortions as an inherent quality, and such distortions are excluded from this limited warranty. Glass with special coatings may require special cleaning. Visit [www.cgiwindows.com](http://www.cgiwindows.com) for additional care and maintenance information and glass policies. Failure to adhere to cleaning and any other recommended care and maintenance will void this limited warranty, as will any of the other exclusions set forth herein, including the exclusions described above.

### Laminated Glass Unit

The glass is warranted to be free of defects that result in material obstruction of vision or delamination for the applicable time period specified in the table above.

### Insulating Glass Unit

The sealed glass component is warranted to be free of defects that result in material obstruction of vision or film formation caused by dust or moisture in the dead air space of a sealed unit, for the applicable period of time specified in the table above.



# LIMITED WARRANTY

### Stress Cracks

Stress cracks in glass panels outside of CGI's Glass Policy guidelines or resulting from natural settlement or extreme thermal changes between inside and outside temperatures are not considered defects in materials and/or workmanship.

### Transferability

This limited lifetime warranty is transferable to subsequent owner(s) as specified herein provided CGI receives notice of transfer of title of the registered property within thirty (30) days after the date of ownership transfer, and provided such notice is accompanied by a copy of this Warranty and the order number for no additional fee. If this limited warranty has not already expired or been voided for other reasons, it will be extended to the subsequent owner for ten (10) years from the date CGI delivers product to our customer's specified location, subject to the conditions, exclusions and limitations described elsewhere in this limited warranty.

### Residential Intruder Protection

For Sentinel and Targa products, CGI warrants that for a period of ten (10) years following the date of delivery to our customer's specified location, CGI will reimburse the original residential homeowner for property loss arising out of a burglary due to an entry through a locked pane of impact-resistant, Missile Class D, glass which has been smashed or broken by a burglar up to a maximum of the owner's insurance deductible (not to exceed One Thousand Dollars (\$1,000)). In order to file a claim, the customer must within 30 days of the burglary provide CGI proof of purchase, a copy of the police report, a copy of the loss claim notice to the customer's insurance company for the burglary and two pictures of the broken Sentinel or Targa window or door which shows the logo of the glass manufacturer.

### Supplemental Commercial Warranty Language: Commercial, Investment, and Non-Owner-Occupied Residential Dwellings

CGI products installed in non-owner-occupied dwellings such as apartments and rental homes, or used for commercial purposes such as schools, churches, hospitals, government owned structures and office buildings are covered by this limited warranty only as set forth in the table below and are subject to all of the exclusions described in this limited warranty, including those exclusions listed on the first page of this limited warranty.

#### THE WARRANTY PERIODS LISTED IN THE TABLE BELOW BEGIN ON THE DATE CGI DELIVERS PRODUCT TO OUR CUSTOMER'S SPECIFIED LOCATION.

	<b>Sparta by CGI®</b> Series 4100A	<b>Sentinel</b> Series 100/238SN	<b>Targa</b> Series 7000
<b>Frame</b>	Excluded	5 years	10 years
<b>Frame Finish</b>	Excluded	5 years	10 years, colored / laminated finishes Excluded
<b>Hardware, Screens and Moving Parts</b>	Excluded	3 years	3 years
<b>Insulating Glass</b>	Not applicable	10 years	10 years
<b>Laminated Glass</b>	Excluded	5 years	5 years
<b>Stress Cracks</b>	Excluded	1 year	1 year
<b>Transferable</b>	Excluded	Excluded	Excluded
<b>Residential Intruder Protection</b>	Excluded	Excluded	Excluded

### Supplemental Export Warranty Language: CGI Products Installed Outside the Continental United States

CGI's liability under this limited warranty shall be limited to the replacement of nonconforming goods or parts or, at CGI's option, refund the amount of purchase paid to CGI, subject to the provisions set forth in the table below. CGI shall not be responsible for on-site inspections or warranty repairs and shall not be responsible for any labor or delivery costs associated with repairing or replacing products, or for any consequential damages.

#### THE WARRANTY PERIODS LISTED IN THE TABLE BELOW BEGIN ON THE DATE CGI DELIVERS PRODUCT TO OUR CUSTOMER'S SPECIFIED LOCATION.

	<b>Sparta by CGI®</b> Series 4100A	<b>Sentinel</b> Series 100/238SN	<b>Targa</b> Series 7000
<b>Frame</b>	Excluded	10 years	10 years
<b>Frame Finish</b>	Excluded	10 years	10 years, 5 years on colored / laminated finishes
<b>Hardware, Screens and Moving Parts</b>	Excluded	3 years	3 years
<b>Insulating Glass</b>	Not applicable	10 years	10 years
<b>Laminated Glass</b>	Excluded	5 years	5 years
<b>Stress Cracks</b>	Excluded	Excluded	Excluded
<b>Transferable</b>	Excluded	Excluded	Excluded
<b>Residential Intruder Protection</b>	Excluded	Excluded	Excluded

### Owner Responsibility

The life of your windows and doors increases with proper care and maintenance, and products require reasonable care and periodic cleaning. In salt-air environments, increased care and maintenance is required. Visit [www.cgjwindows.com](http://www.cgjwindows.com) for additional care and maintenance information. The failure to follow recommended cleaning care and maintenance requirements will void this limited warranty.

### Claim Procedure

Any claim for defect under this limited warranty must be submitted promptly after discovery to the independent dealer or distributor from whom the product was purchased and within the warranty period specified above. If you cannot locate the independent dealer or distributor from whom the product was purchased, you may contact CGI for assistance at [warranty@cgjwindows.com](mailto:warranty@cgjwindows.com) or call **800-282-6019**. To help us serve you better, all claims must include proof of purchase, product identification or order number, the address where the product is installed, and a description of the problem.

Some states do not allow the exclusion or limitation of incidental or consequential damages or the limitation of remedies for a breach of warranty, so the above limitations or exclusions may not apply to you. This warranty gives you specific legal rights, and you may also have other rights that vary from state to state.

**\*\*\* NO DISTRIBUTOR, DEALER, OR REPRESENTATIVE OF CGI HAS THE AUTHORITY TO CHANGE OR MODIFY THIS WARRANTY IN ANY RESPECT, EITHER ORALLY OR IN WRITING. EXCEPT AS EXPRESSLY PROVIDED IN THIS WARRANTY. CGI MAKES NO WARRANTY, EXPRESS OR IMPLIED, INCLUDING NO WARRANTY OF MERCHANTABILITY, NO WARRANTY OF FITNESS FOR PARTICULAR PURPOSE, AND NO WARRANTY OF NONINFRINGEMENT, AND CGI DISCLAIMS ALL WARRANTIES NOT EXPRESSLY PROVIDED HEREIN. \*\*\***